

— Restoration & Moisture & Ventilation —

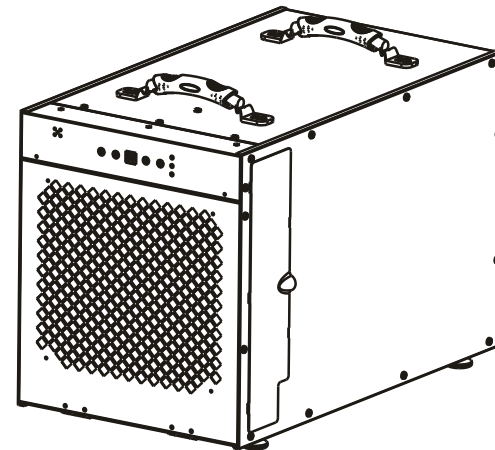

Sentinel HDi120

Installation and Operations Manual



AlorAir Solutions INC.

Add: 4240 Latham Street, Suite D, Riverside, CA 92501

Tel: 888-990-7469

E-mail: sales@alorair.com

Table of Contents

- Important Notes 2
- Warranty Registration 2
- Specifications 3
- How it Works 3
- Installation Requirements 3
- Installation 4
- Key Functions 4
- Indicator Lights 5
- Remote Control 6
- Operating Instructions 7
- Unit Diagram 8
- Maintenance 9
- Dehumidifier Storage 11
- Ducted Applications 11
- Troubleshooting 12
- Spare Parts 13
- Warranty Information 14

■ Important Notes

- Always connect your dehumidifier using a grounded electrical connection (as required for all electrical appliances). The use of non-grounded wiring will void the warranty.
- Your dehumidifier should only be repaired by a qualified technician.
- Do not use the dehumidifier in standing water. If there is a chance that the dehumidifier has been flooded, unplug the unit, remove the cover, and allow it to dry completely before proceeding.
- Do not insert objects or your fingers into the inlet or discharge.
- Do not use water to clean the exterior of the dehumidifier. To clean unit, unplug from power, then use a damp cloth to wipe the exterior.
- Do not stand on dehumidifier or place objects on it.
- Do not use with extension cord or plug adapter.
- Unless otherwise noted, all maintenance should be done with the unit powered off.

■ Warranty Registration

Your dehumidifier comes with an extensive warranty.

For future reference, write down the model, serial number, and date of purchase for your dehumidifier. This information is necessary for seeking assistance in the future and can be found on the data label on the side of the unit.

Model Number: ALORAIR Sentinel HDi120

Serial Number: _____ **Date of Purchase:** _____

For additional questions concerning your dehumidifier, contact your local installer or call AlorAir at 888-990-7469

Specifications

Capacity @ 80°F/60%RH: 120 Pints Per Day
 Capacity @ 73°F/60%RH: 93 PPD
 Airflow: 290 CFM
 Operating Temp. Range: 33.8-104°F
 Operating Relative Humidity Range: 35%-90%
 COP: 2.7 L/kWh
 Refrigerant: R410A
 Amperage Usage: 7.8 Amps
 Power Supply: 115V/60Hz/Single Phase
 Outlet Requirement: 15 Amp, 3 prong, GFCI
 Sound Level: 60 dBA
 Dimensions LxWxH: 23.8" x 14.7" x 17.9"
 ETL Listed: Yes

How It Works

AlorAir dehumidifiers use an integrated humidistat to monitor the conditioned space. When the relative humidity goes above the selected setpoint, the dehumidifier will energize. Air is then drawn across an evaporator coil, which is cooler than the dew point of air. This means moisture will condense out of the air. The air is then reheated through the condenser coil and distributed back into the room.

Installation Requirements

- The area where the dehumidifier is located should be sealed with a vapor barrier.
- If the unit is installed in a crawl space, all vents should be sealed.
- For proper ventilation, neither the inlet or discharge should be positioned against a wall. The inlet needs a minimum of 12" clearance and the discharge requires a minimum of 36" clearance.
- For the best air diffusion, install the unit so that a side panel faces the wall.
- Alorair dehumidifiers are only intended for operation when the unit is upright and level with the feet on the ground.

Installation

1. Place dehumidifier on a level surface.
 - Do not place unit directly on vapor barrier. For example, use blocks or pavers to create a level surface.
 - If unit has been turned or flipped so that the compressor did not remain upright, place the unit on a level surface and wait a minimum of 2 hours before proceeding.
2. Set up the drain line
 - Remove the compression nut and slide it over the end of the hose to be attached to unit.
 - Slide the side of hose with compression nut over the insert on the compression fitting completely.
 - Tighten compression nut.
3. Plug dehumidifier into grounded 15 amp circuit.

Key Functions



1. Power Key

- Use this button to turn the dehumidifier on and off.
- Press once to turn machine on. You will hear two beeps and the  will illuminate green (solid or flashing depending on mode).
- Press the power button a second time and you will hear one beep as the machine shuts down. Note that there is a 1 minute fan delay.

2. Arrow Buttons

- Use the up and down arrow buttons to set the desired humidity setpoint on the display screen. 
- The setpoint can be any number between 36%-90%. When the indoor humidity is higher than the setpoint, the unit will operate.
- Keep in mind that the displayed humidity levels are approximate (+/-5%)

3. Continuous Mode

- To set the unit to run continuously regardless of humidity, simply use the down arrow key to set the humidity below 36%.

- The continuous light will illuminate green and the display will show “CO”.
- To switch back to normal humidistat operation, use the arrow keys to move the setpoint above 36%.

4. Manual Drain Button

- If you need to store or move your dehumidifier, press the “Drain” button to remove water from the integral pump’s reservoir.

Indicator Lights

1. Humidity Display Screen

- The display screen has two functions:
 1. When the unit is powered on, it shows the humidity of the space
 2. When setting the desired humidity level, the screen will show the set point. After a brief delay, it will revert to current humidity of the space.

2. Power Indicator Light

- This light indicates that the unit is properly powered on and ready to operate.
- Always make sure the unit is “off” prior to performing any service, unless otherwise indicated.
- If the humidity is above the setpoint, the light will be solid green and the machine will operate.
- If the humidity is below the setpoint, the unit will be in standby mode and the light will be flashing.

3. Continuous Mode/ Auto Defrost Light

- When the light illuminates green, it indicates that the dehumidifier is set to continuous operation mode.
- When the light illuminates red, it means the unit is in auto defrost mode and clearing the evaporator coils of any ice buildup.

4. Compressor Light

- When the light illuminates red, it indicates the compressor has been initiated but is currently warming up.
- Once the light switches to green, it means the compressor is currently in working status.

Remote Control Instructions

AlorAir Dehumidifiers can be controlled using an optional remote accessory. The remote connects to your dehumidifier via a 25' CAT 5 cable, with the integrated sensor giving you multiple options for monitoring surrounding conditions.

Example #1- Install the dehumidifier in the laundry room and duct it into the living room. Mount the remote in the living room and use the remote sensor.

Example #2- Install the dehumidifier in your crawl space with the remote mounted in your garage.

NOTE: The symbols indicated below only show when the remote is powered on.

1. On/Off (Power) Button



Press the on/off button and the machine will start running (two beeps). Press the button again to turn the machine off.

2. Up Button/ Down Button

Use the up and down arrows to adjust the humidity level.

3. Mode

Use the mode button to switch between dehumidifier and a ducted application.

- The  symbol on the display indicates the sensor on the remote control is being utilized.
- The  symbol on the display indicates the sensor on the dehumidifier is being utilized.

4. Temperature

Press the temperature button to display the current temperature on the screen

5. Continuous

Press this button to switch the unit into continuous mode. “CONT.” will appear on the display screen.

6. Drain Pump

Use this button if the unit will not be used for an extended period of time. This button will remove water from the pump reservoir.

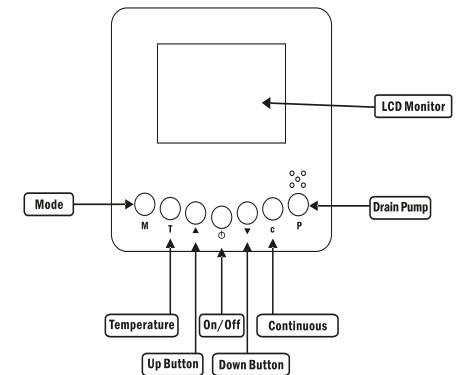

Operating Instructions

1. Start the machine

- Press the power key to turn the dehumidifier on.

2. Adjust the settings

- Use the up and down arrow keys to adjust your desired setpoint (typically 50-55%)

3. Stop the machine

- Press the power button again and the dehumidifier will stop. Note that the fan will continue to operate for 1 minute after the unit has shut off.

DO NOT DISCONNECT THE POWER CORD TO FORCE THE UNIT TO STOP.

4. Water Drainage

- The AlorAir Sentinel HDi120 has an integrated condensate pump. During normal operation, the HDi120 will automatically drain as required.

- If you would like to store or move your unit, press the drain button to drain water from the pump reservoir. The drain will operate for 15 seconds each time the button is pushed. It may be necessary to push the button more than once.

Unit Diagram

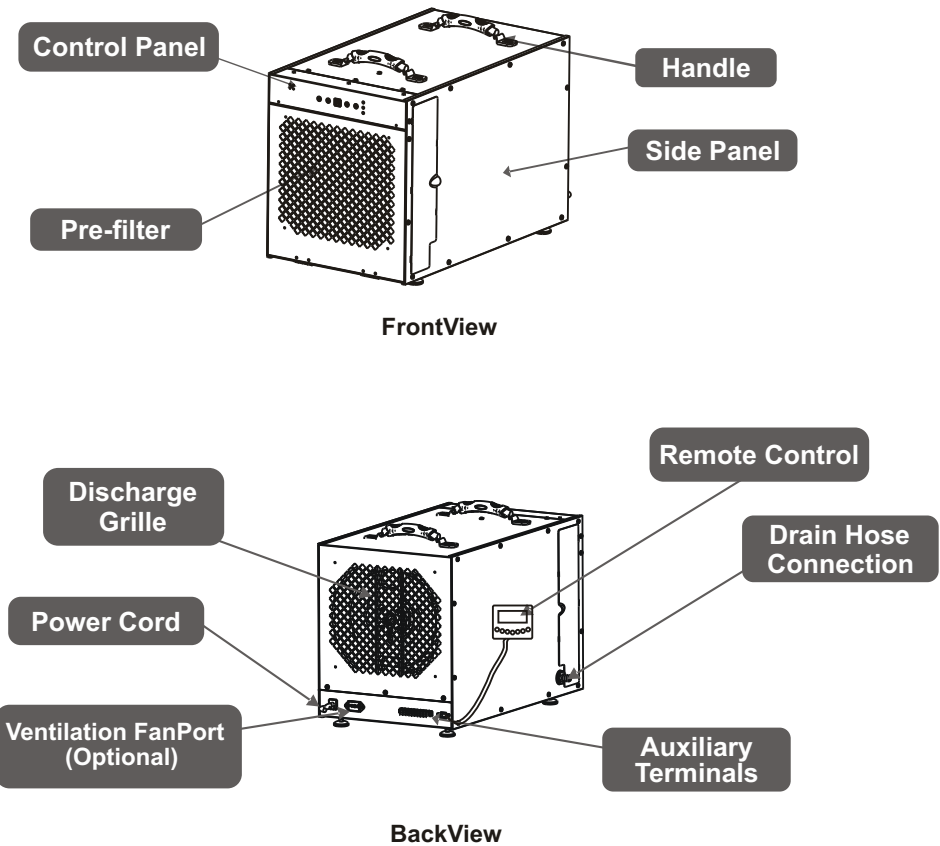

Maintenance

For more detailed instructions, visit www.alorair.com

⚠ WARNING: Always unplug the unit before doing any maintenance.

Cleaning the Machine Body

- Use a soft, damp cloth to clean the exterior of unit. Do not use any soap or solvents

Coil Maintenance

- Once per year, clean the coils with an approved coil cleaner. The coil cleaner should be a self-rinsing, foaming, cleaner, such as WEB® Coil Cleaner.

Cleaning the Filter

1. Unplug the unit.
2. For PreFilter:
 - a. Remove prefilter from inlet of machine.
 - b. Vacuum or wash with warm water (no soap).
3. For MERV-10/HEPA/Carbon Filters:
 - a. Replace as necessary- we recommend checking the filters at least 1x/year

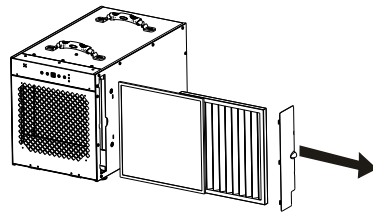

Electrical Access

- Unscrew the 13 screws on the side panel.
- Remove the 2 screws on the control board cover.

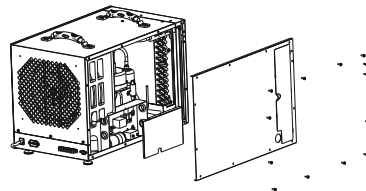

Pump Maintenance

Your AlorAir Sentinel HDi120 is equipped with an integral condensate pump designed to pump water from the dehumidifier out to the desired drain.

The pump requires routine maintenance that is not covered by the warranty.

Preventative maintenance is necessary to prevent issues from dirt and slime that may accumulate in the drain system. This includes the drain pan, hose to the condensate pump, pump reservoir, pump head assembly, and discharge tubing.

Removing the Pump

1. Remove the 9 screws on the side panel and set panel aside.
2. Remove the screw holding the pump in place.
3. Undo the 3 pump electrical quick connects and 1 drain quick connect.
4. Insert a flat head screwdriver into the notch on the side of the pump. This will allow you to gently lift the pump off its reservoir (the reservoir remains attached to the unit).

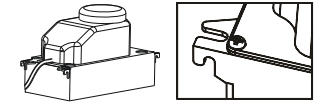

Basic Pump Cleaning

Complete about once per year, depending on environment

1. Remove filter(s) from inlet of unit to access drain tray. Press the drain button to drain the reservoir.
 2. Disconnect power to the dehumidifier.
 3. Mix a 16 ounce solution of bleach (1 oz bleach + 15 oz water) OR vinegar (4 oz white vinegar + 12 oz water).
 4. Pour the cleaning solution into the drain tray at the base of the coils.
- If any cleaning solution gets on the coils, flush with water.
5. Allow solution to soak for 15 minutes.
 6. Reconnect the dehumidifier to power.
 7. Fill the reservoir with water (16-32 ounces) and flush/cycle the pump at least 2x.
 8. If the drain line is still filled with debris, repeat process. If drain line still does not appear clean, move on to Advanced Cleaning.

Advanced Pump Cleaning

Complete as needed

1. Press the drain button to drain the water from the reservoir (a wet-dry vacuum or towels can be used to remove any remaining water).
 2. Unplug the dehumidifier and remove the cover so you have access to the pump.
 3. Remove the pump head from the reservoir by unscrewing the screw.
- Wipe reservoir clean with a paper towel.
4. Reassemble pump.
 5. Mix a 16 ounce solution of bleach (1 oz bleach + 15 oz water) OR vinegar (4 oz white vinegar + 12 oz water).
 6. Pour the cleaning solution into the drain tray at the base of the coils.
- If any cleaning solution gets on the coils, flush with water.
7. Allow solution to soak for 15 minutes.
 8. Reconnect the dehumidifier to power.
 9. Fill the reservoir with water (16-32 ounces) and flush/cycle the pump at least 2x.

Dehumidifier Storage

If the unit will be stored for an extended period of time, complete the following steps:

1. Turn off the unit and allow it to dry.
2. Complete steps 1-3 in Advanced Pump Cleaning to clean out the pump reservoir.
3. Wrap and secure the power cord.
4. Cover the filter mesh.
5. Store in a clean, dry space.

Ducted Applications

Ducting the dehumidifier allows the unit to be in one room while conditioning an adjacent room. Both the inlet/return grille and the supply grille are designed for 10" flex ducting.

Ducting Installation Notes

- Be sure to secure the ducting with tie wrap.
- Maximum total length of duct run = 10'
- Inlet and outlet duct adapters are optional accessories

Duct Adapter Installation

- Screw in the 4 screws on each duct adapter.

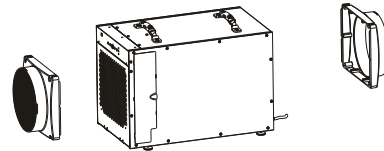

Flex Duct Installation

- Slide ducting over adapter and secure with tie wrap or clamps



Troubleshooting

Symptom	Cause	Solution
Display is Blank	Poor Connection	Verify that both ends of the power cord are plugged in
	Power Outage	Reset power
No Air Flow	Filter is Dirty	Clean the filter
	Air Inlet or Outlet is Blocked.	Clear the blockage
Trouble Code: E1	Humidity Sensor or Communication Error	Check to ensure that the sensor wire is connected at both ends, if no issues are visible, the sensor may be faulty.
Trouble Code: E4	Problem with Pump	Verify that the pump is properly installed and functioning. If so, unplug the unit for two minutes, then restart.
Trouble Code: LO	Room Temperature is below 33.8°F	Increase the room temperature so it is within operation range (above 33.8°F). If error still display, check sensor.
Trouble Code: HI	Room Temperature is above 105°F	Decrease the room temperature so it is within operating range (below 105°F). If error still displays, check the sensor.
E5 Trouble Code	Refrigerant Leak	Contact Your Installer for Assistance.

Pump Alarm- E4 Error Code

****UNIT WILL NOT FUNCTION UNTIL ERROR CODE IS CLEARED.**

If E4 (pump alarm) is shown on the display, complete the following steps:

1. Reset the unit by unplugging the power cord and then reconnecting it.
2. Manually check to see if the pump is operational by pressing the drain button. Check if the pump energizes and de-energizes properly. Additionally, check to see if any water purged from the system.
3. If you haven't cleaned the system recently, check the discharge line for an obstruction, then clean as described in the Maintenance section.
4. Replace the hose and/or pump, if maintenance alone isn't sufficient.

Spare Parts

Remote Control	
W-100	Remote Control Assembly (includes W-101 and W-102)
W-101	AlorAir Remote Control
W-102	AlorAir Remote Control Cable

Display/Control	
N-100	AlorAir Main Control Board
N-101	AlorAir Display Board
N-102	AlorAir RH/Temp. Sensor

Internal Components	
N-801	Compressor
N-118	Compressor Capacitor
N-800	Coil Assembly
N-119	Hot Gas Valve Assembly
N-803	Condensate Pump Assembly

Fan Components	
N-802	AlorAir Fan Motor
N-804	AlorAir Complete Fan Assembly
N-117	Fan Capacitor

Filters + External Components	
N-200	AlorAir Prefilter
N-201	AlorAir MERV 10
N-202	AlorAir HEPA
N-203	Carbon Filter
N-125	Foot, adjustable

Cables	
N-102	Temp/RH Sensor Cable
N-121	Display Ribbon Cable
N-122	CAT 5 Port Internal Cable

Duct + Ventilation Accessories	
N-103	AlorAir Return + Supply Duct Collar Assembly
N-105	AlorAir Remote Control

Limited Warranty

All warranty benefits apply to the original owner only. Warranty cannot be transferred or assigned.

1 YEAR (FROM DATE OF PURCHASE): AlorAir warrants the dehumidifier will operate free of defects in workmanship and materials. At its discretion, AlorAir will repair or replace any malfunctioning components, free of charge (excluding transportation costs)

3 YEARS (FROM DATE OF PURCHASE): AlorAir warrants the refrigeration circuit (compressor, condenser and evaporator) will operate free of defects in material or workmanship. At its discretion, AlorAir will replace defective parts, including factory labor or refrigerant. This does not include transportation.

5 YEARS (FROM DATE OF PURCHASE): AlorAir warrants the compressor, condenser, and evaporator will operate free of any defects in material or workmanship. At its discretion, AlorAir will repair or replace the defective parts. This does not include labor, transportation, or refrigerant.

CUSTOMER RESPONSIBILITIES: In order to take advantage of the warranty service, the customer must do the following:

1. Customer must provide normal care and maintenance (including, but not limited to cleaning filters, coils and pumps)
2. Removal and re-installation of unit is the sole responsibility of owner.
3. If customer cannot return unit to certified repair center, all costs associated with freight shipment are borne by the customer. In addition, all duties related to freight shipments, including but not limited to palletizing, wrapping, labeling and pickup are associated with customer.
4. If shipped, customer is responsible for all risk of loss or damage.

Alorair Warranty Steps:

1. Once the goods are received, customers must log in www.alorair.com to fill out the warranty Registration form and submit to AlorAir company. We will receive your purchasing and installation information and save it. If no warranty registration is sent to us, warranty period will begin the day the shipment left the warehouse. Please be sure to record serial # and date of installation. You will need this information to receive the RA number.
2. If warranty service is necessary, customers must contact AlorAir Tech Support by sales@alorair.com or local technical service phone to receive a Return Authorization (RA number). Once an RA has been issued, customers should bring the unit to a certified repair center. AlorAir will arrange the shipping to bring the unit back to the Alorair warehouse (at the expense of the customers) if customers are not available.
3. After the unit has been received by AlorAir (whether at a repair center or the warehouse), AlorAir will have an initial inspection. If it is determined to be an invalid warranty claim (see exclusions below), customers have to pay for all associated repair costs and shipping costs for units repair.
4. Customers can pick up the unit after repair at their own expense for shipping. Units will have a rigorous testing before sending it back to customers.
5. If the unit can no longer be fixed, and it is in the warranty period and determined to be a valid claim, we will ship the customer a new unit within the same year warranty from the date of replacement.
6. After parts are repaired or replaced by AlorAir, the original warranty period continues to apply until it meets its deadline. No extensions to the original warranty period.

Limited Warranty Exclusions

EXCLUSIONS:

DAMAGE DUE TO THE FOLLOWING IS NOT COVERED UNDER WARRANTY

1. ACTS OF NATURE- INCLUDING BUT NOT LIMITED TO:

- FLOODING
- FIRE
- WATER DAMAGE
- HURRICANE STORM DAMAGE

2. IMPROPERUSAGE-INCLUDING BUT NOT LIMITED TO:

- POOL/SPA/TUB APPLICATIONS
- MISUSE, ABUSE OR TAMPERING WHETHER INTENTIONAL OR ACCIDENTAL
- IMPROPER INSTALLATION OR DESIGN
- IMPROPER VOLTAGE
- LACK OF NORMAL CARE
- FAILURE TO FOLLOW INSTRUCTIONS

3. CORROSION

4. FREEZING

5. ANY ADDITIONAL COSTS DUE TO CHANGES IN LAWS OR BUILDING CODES

6. FREIGHT CHARGES

7 ANY COSTS DUE TO LOST PROFIT OR DELAY

8. DAMAGE TO PROPERTY

9. CAUSE BEYOND CONTROL

10. CONSUMABLE PARTS INCLUDING BUT NOT LIMITED TO:

- FILTERS
- BATTERIES
- POWER CORDS
- VALVES
- SWITCHES
- RUBBER PARTS

11. DIRECT, INDIRECT, COLLATERAL OR INCONSEQUENTIAL DAMAGES OF ANY KIND

THE WARRANTIES AND LIABILITIES SET FORTH ARE IN LIEU OF ALL OTHER WARRANTIES EXPRESSED OR IMPLIED IN LAW OR IN FACT, INCLUDING IMPLIED WARRANTIES OF MERCHANTABILITY AND FITNESS FOR PARTICULAR PURPOSE. Alorair's total liability, regardless of nature of claim shall not exceed original purchase price of the product, if a product or component is replaced while under warranty, the applicable warranty period shall not be extended beyond the original warranty time period.

The foregoing shall constitute the total liability of seller in the case of defective performance of all or any of the equipment or services provided to buyer. Buyer agrees to accept and hereby accepts the foregoing as the sole and exclusive remedy for any breach or alleged breach of warranty by seller.

Any dishonesty or fraud in connection with Alorair warranty thoroughly voids all warranty policies.

Alorair expressly reserves the right to pursue legal action in the event of dishonesty, fraud, or attempted fraud.